

Not included / Non incluso / Non Inclus / Nie zawarty / No incluido / Nao incluido

1



A1

A2

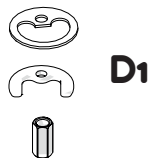

D1



D2

DISPONIBILE SOLO PER ALCUNE SERIE
AVAILABLE ONLY FOR SOME SERIES

ANELLO DI GUIDA
GUIDE RING

118/1

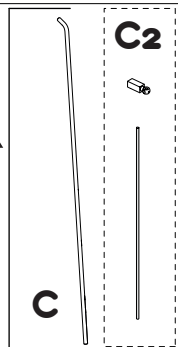

C2

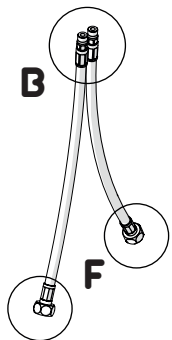

B

F

118/1

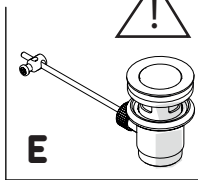

E

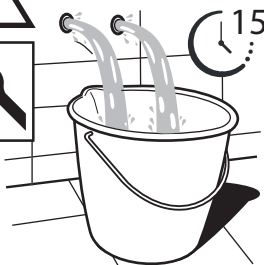
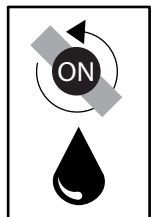

15s

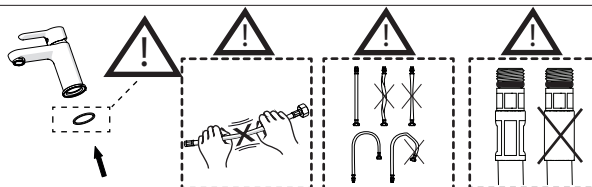
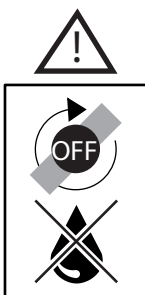

2

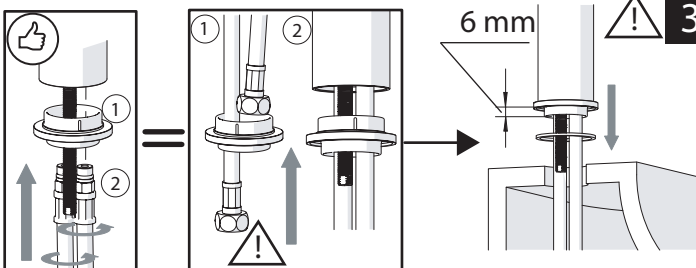
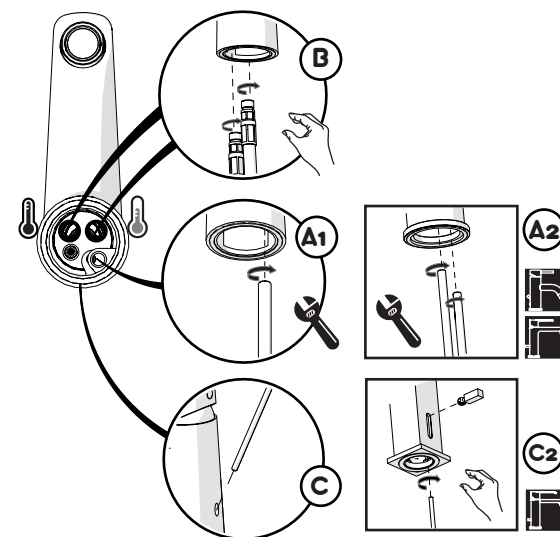

3

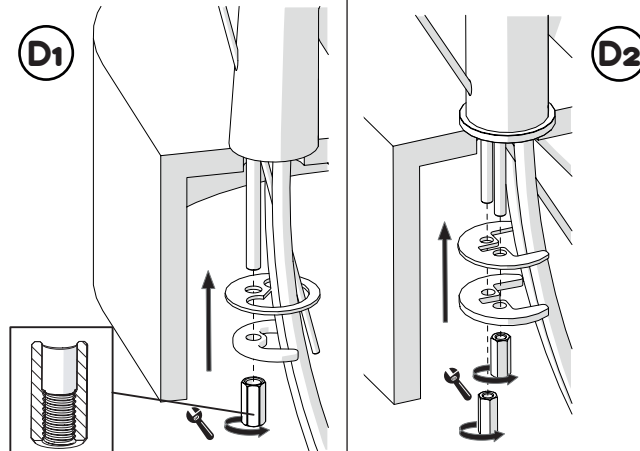

D1

D2

4

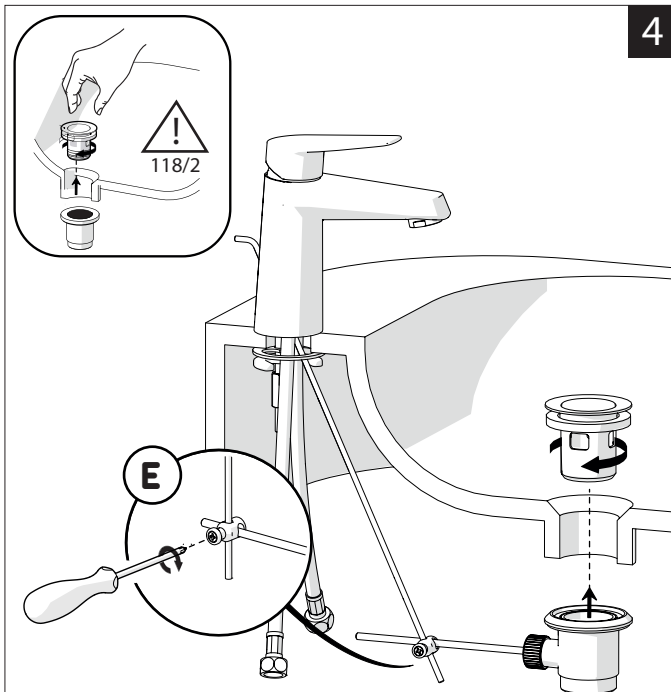

E

5

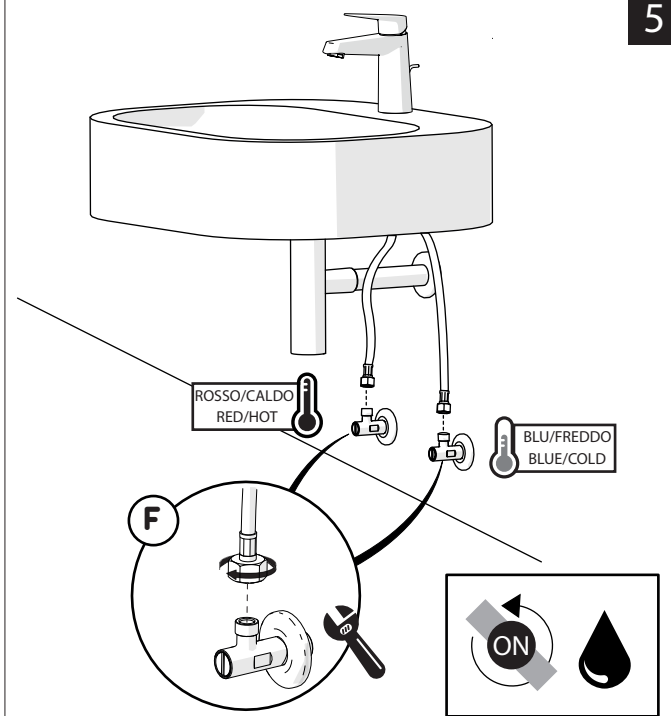

ROSSO/CALDO
RED/HOT

BLU/FREDDO
BLUE/COLD

F

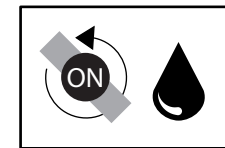



Dispositivo limitatore "dinamico" della portata d'acqua "50%"

"Dinamic" flow rate restrictor "50%"



VARIE POSSIBILITA' PER SMONTARE L'AERATORE
SEVERAL OPTIOS FOR REMOVING AERATOR



ESEMPI DISEGNO TECNICO
EXAMPLES OF TECHNICAL DRAWING

6

CLOSE ON 50% ON 100%

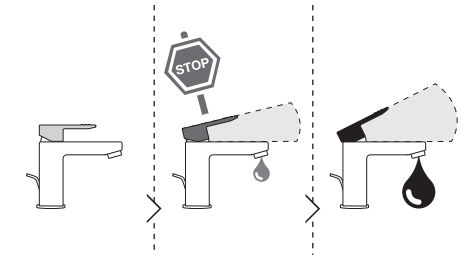

Posizione di chiusura
Closed position

Posizione di risparmio acqua "50% portata"
Position of water saving "50% capacity"

Posizione di apertura totale 100% portata
100% Fully open flow

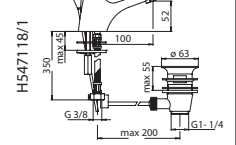
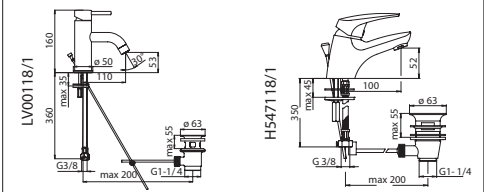
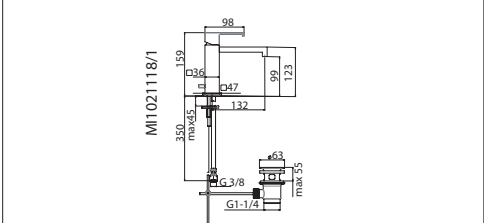
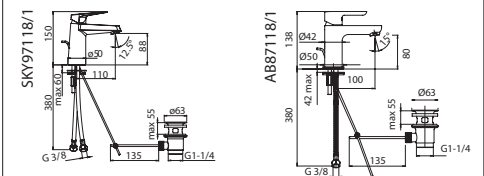
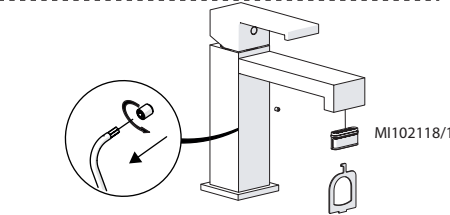
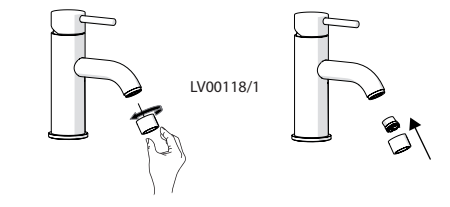
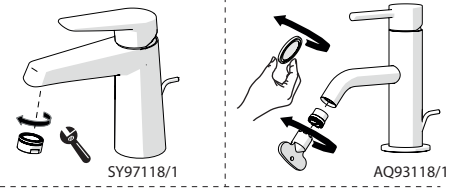
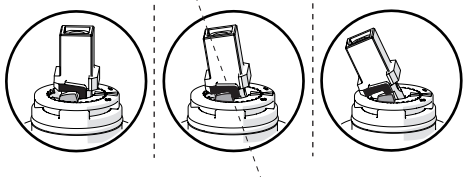

7

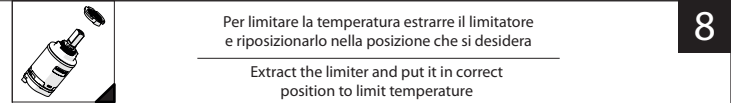
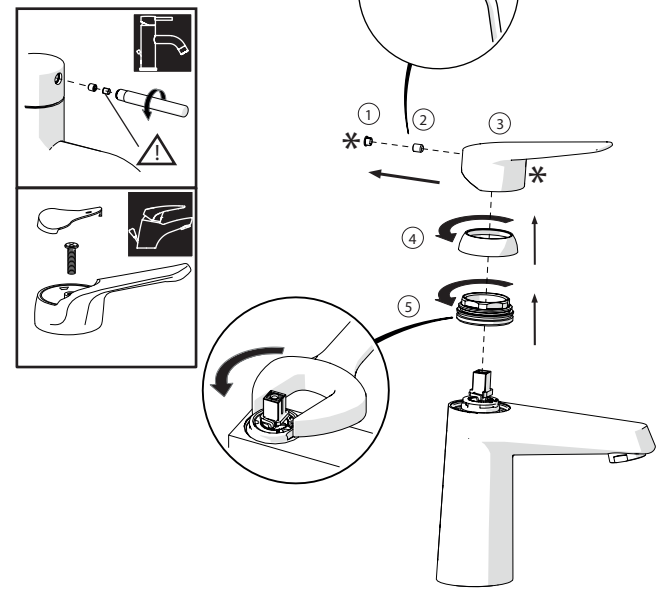

8

Per limitare la temperatura estrarre il limitatore e riposizionarlo nella posizione che si desidera

Extract the limiter and put it in correct position to limit temperature

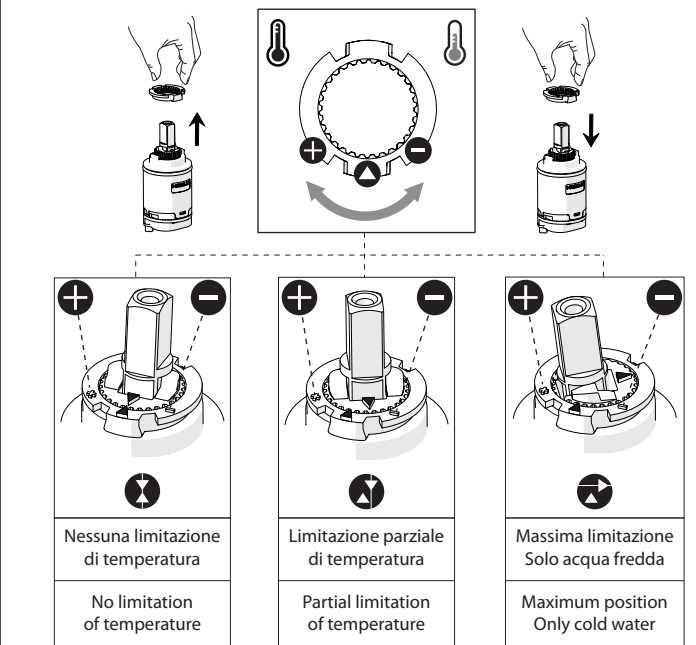

Nessuna limitazione di temperatura
No limitation of temperature

Limitazione parziale di temperatura
Partial limitation of temperature

Massima limitazione Solo acqua fredda
Maximum position Only cold water

NOBILIS

118

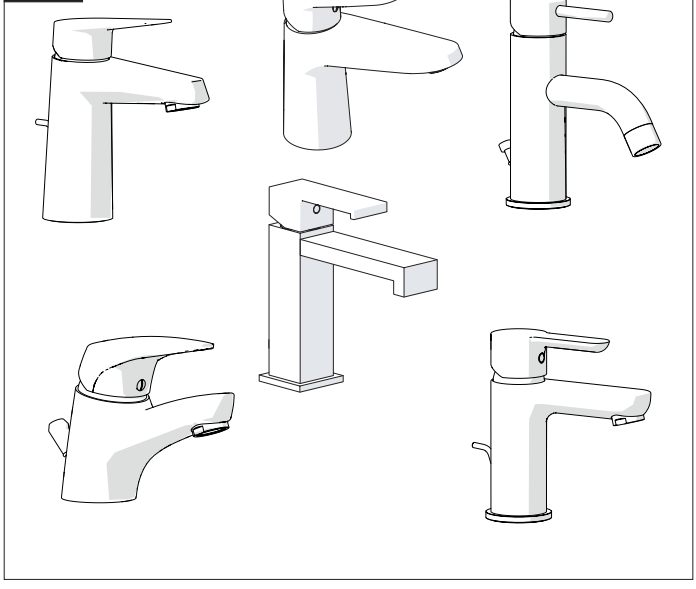

www.nobili.it

PRIMA DI INIZIARE / BEFORE STARTING

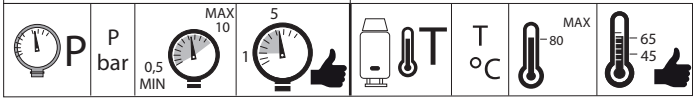

PULIZIA / CLEANING



IISTR00118#---STD



REV4.07/2020

Достоверную информацию уточняйте на santehnica.ru.