

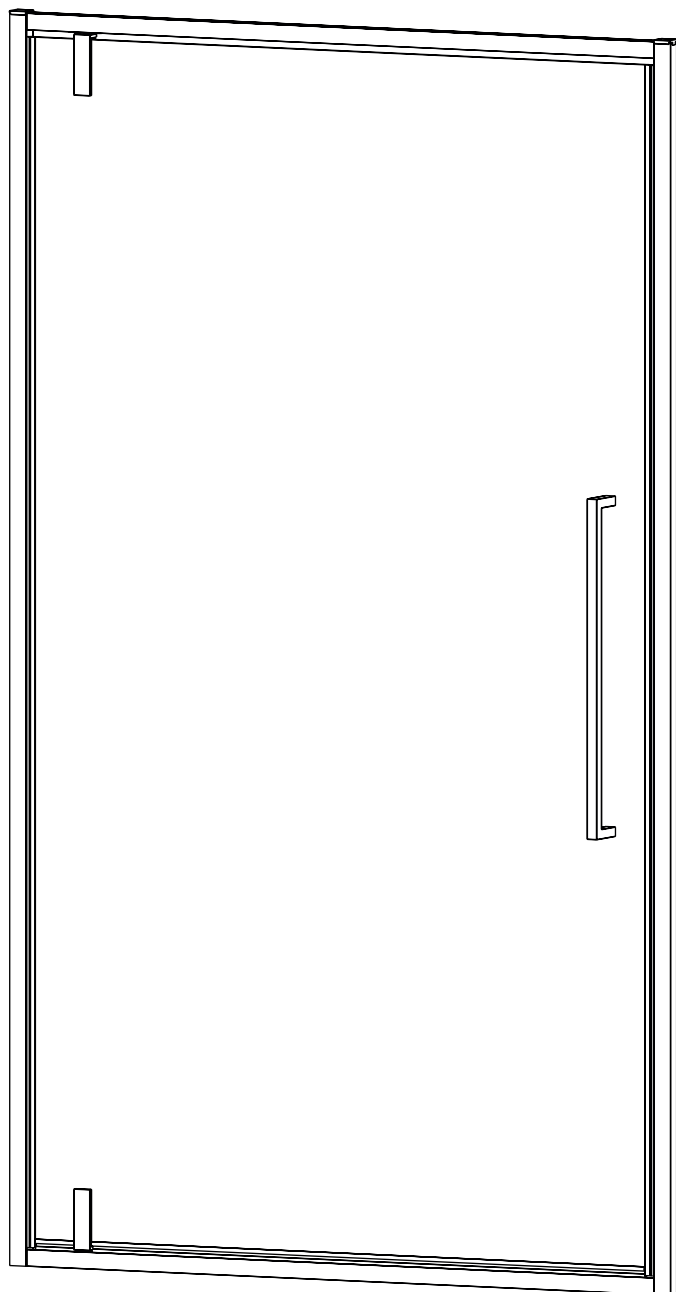

Душевая дверь

VN-33/33B



Инструкция по установке

Пожалуйста, прочитайте инструкцию перед установкой

 Перед установкой поддон для душа должен быть выставлен по уровню и полностью герметичным к плитке.

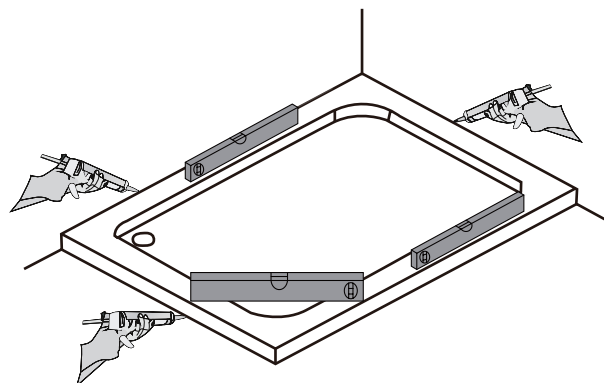

## Необходимые инструменты и оборудование



Карандаш

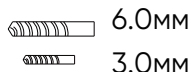

Сверло



Отвертка

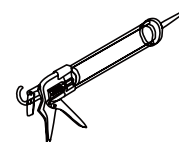

Силикон

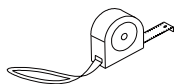

Рулетка

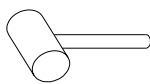

Молоток



Уровень



Дрель

Данная модель с универсальной установкой открывания двери

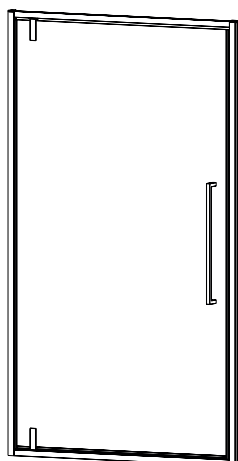

Левая ориентация

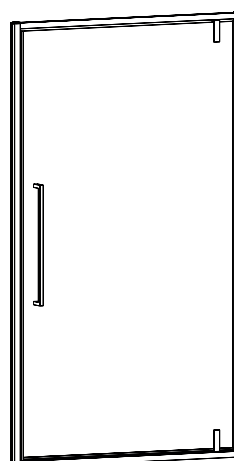





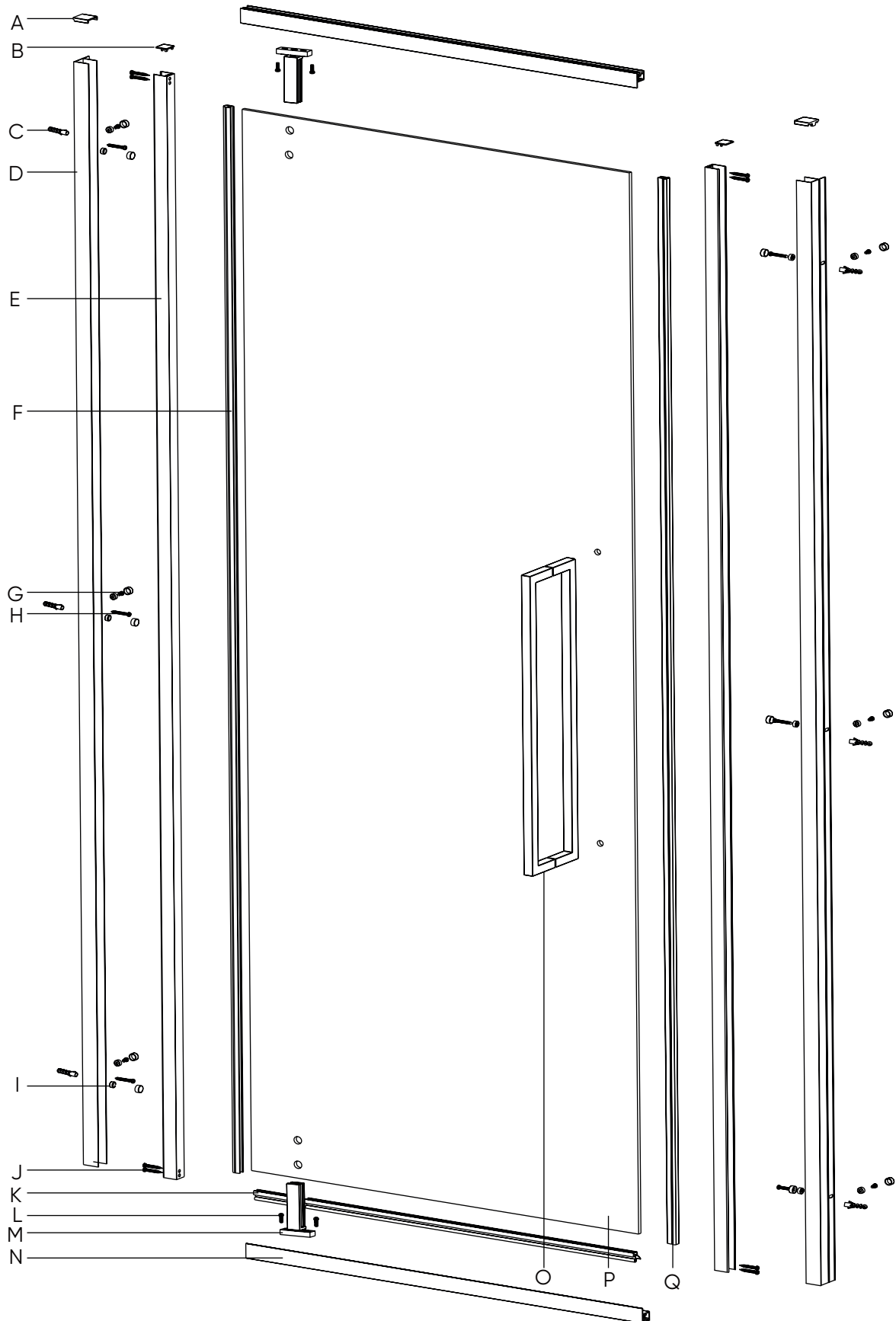



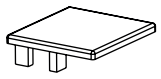
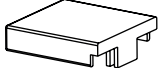

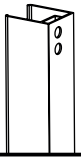
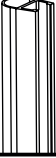

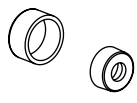
Правая ориентация

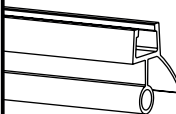
## Общий вид душевой двери

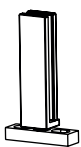

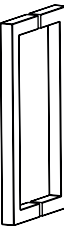
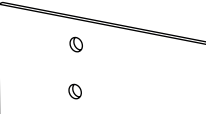
## Перечень деталей

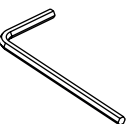
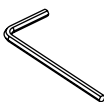
|   |  |   |   |
|---|--|---|---|
| <p>Ax2</p>     | <p>Bx2</p>                  | <p>Cx6</p>                | <p>Dx2</p>                 |
| <p>Ex2</p>    | <p>Fx1</p>                 | <p>Gx6</p>  <p>ST4*8</p>  | <p>Hx6</p>  <p>ST4*35</p>  |
| <p>Ix12</p>  | <p>Jx8</p>  <p>ST4*25</p> | <p>Kx2</p>               | <p>Lx4</p>  <p>M4*10</p> |
| <p>Mx2</p>   | <p>Nx2</p>                | <p>Ox1</p>              | <p>Px1</p>               |
| <p>Qx1</p>   | <p>x1</p>  <p>4MM</p>     | <p>x1</p>  <p>2.5MM</p> |   |

## Шаг 1

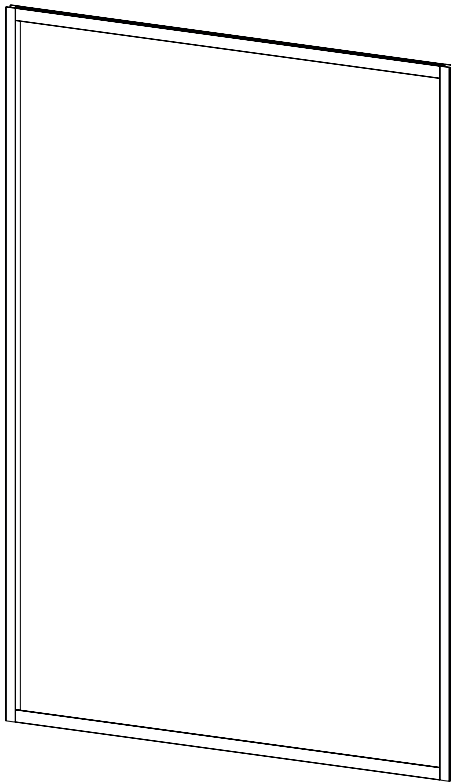

| Артикул           | Регулировка(мм) |
|-------------------|-----------------|
| VN33/33B-70-01-C7 | 690-710         |
| VN33/33B-80-01-C7 | 790-810         |
| VN33/33B-90-01-C7 | 890-910         |

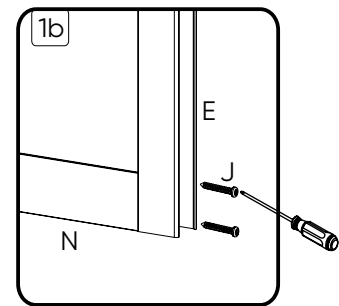
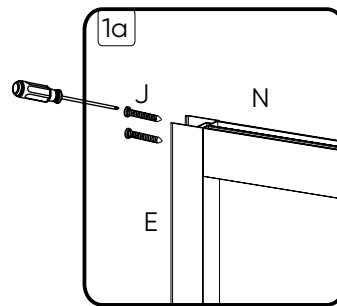

## Шаг 2

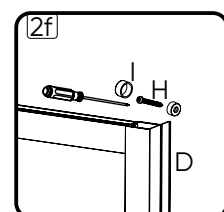
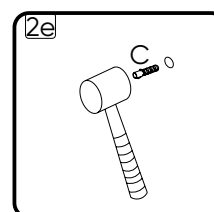
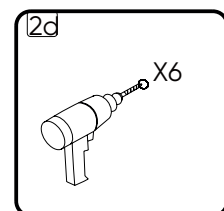
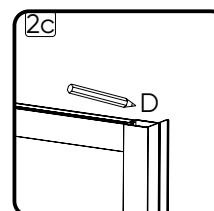
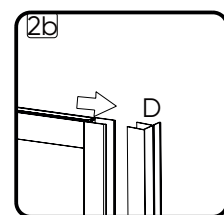
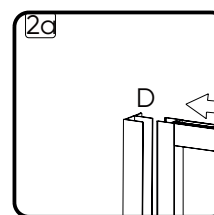
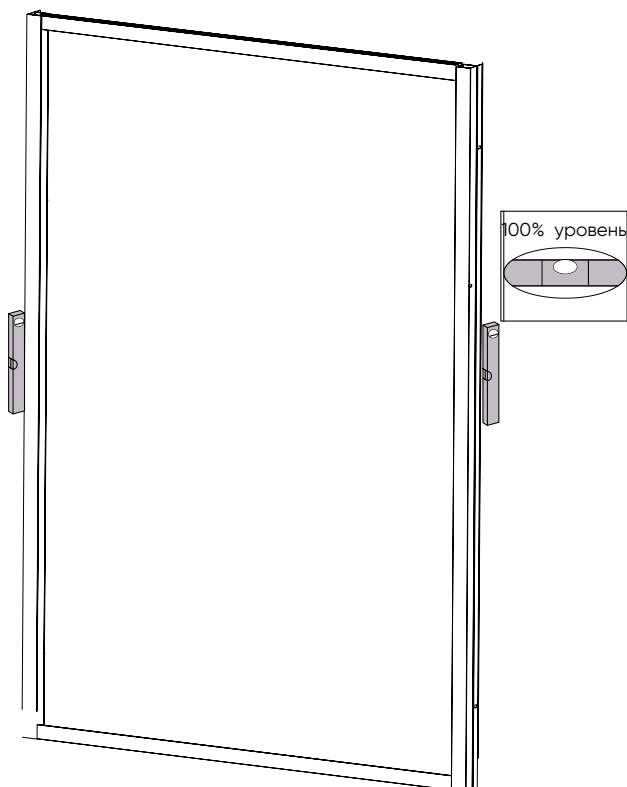

## Шаг 3

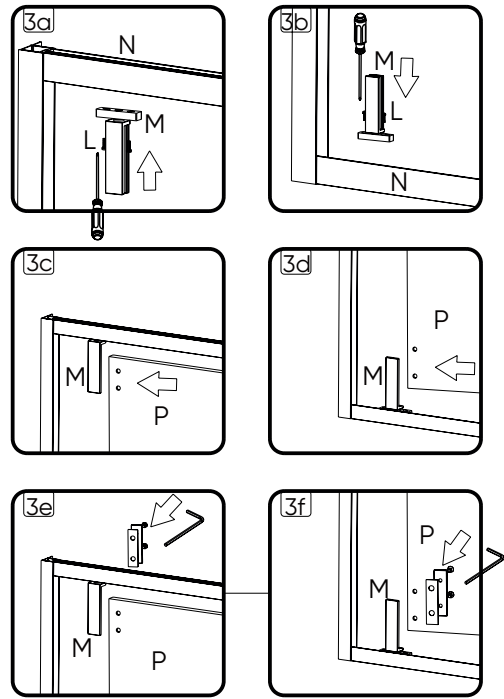
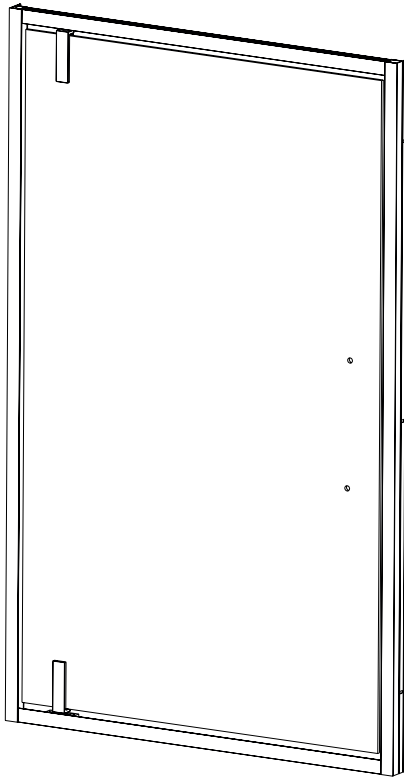

## Шаг 4

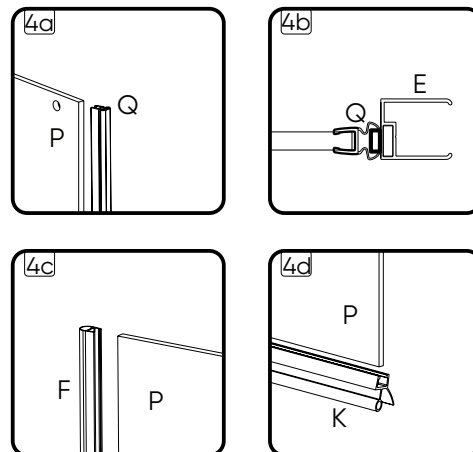
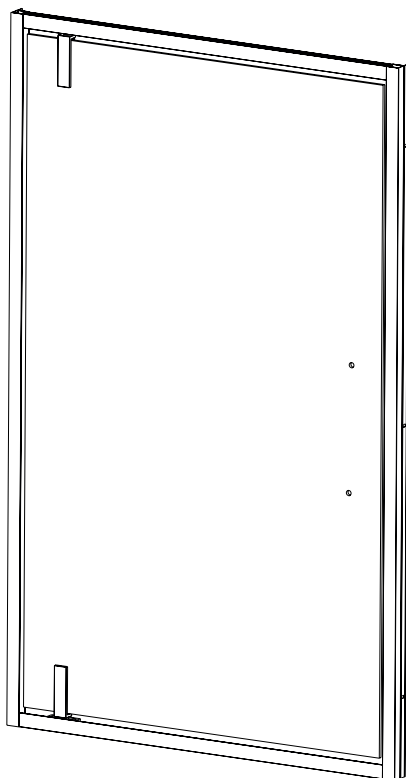

## Шаг 5

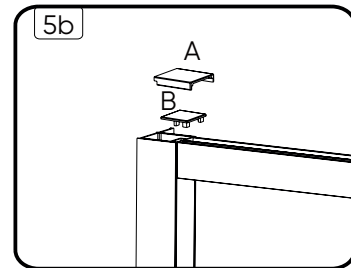
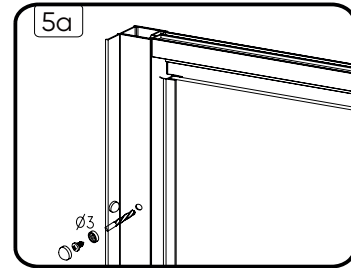
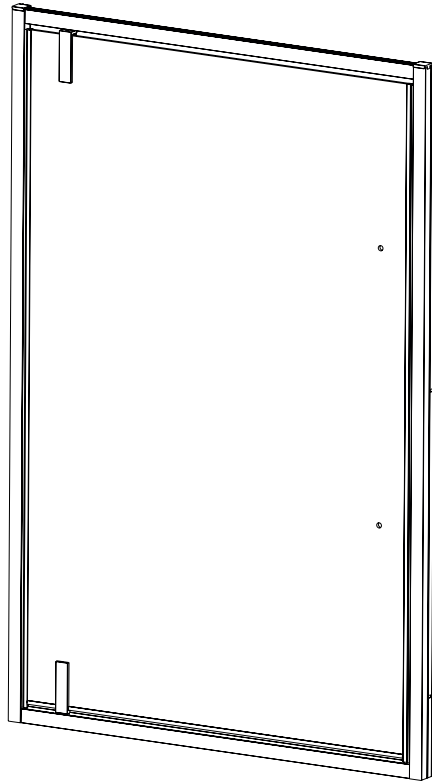

## Шаг 6

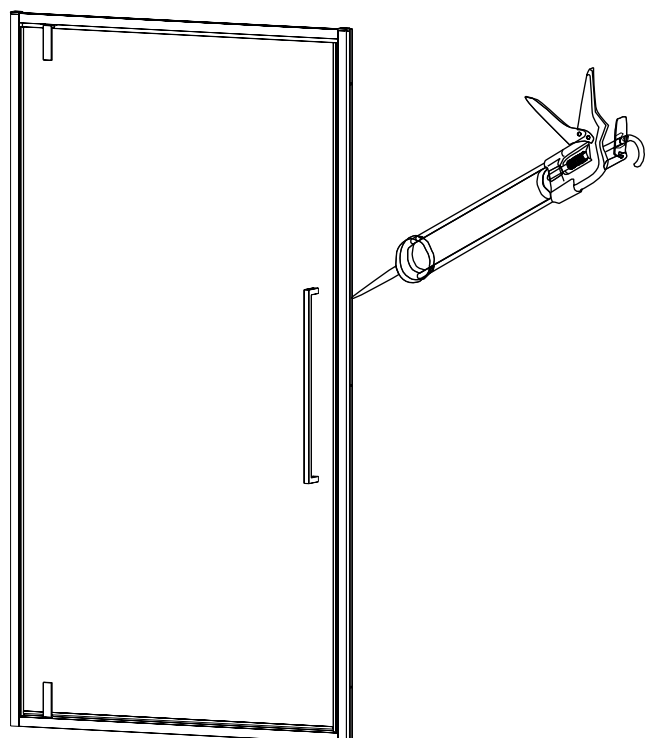
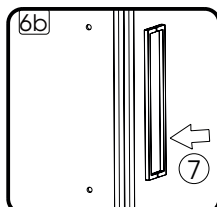
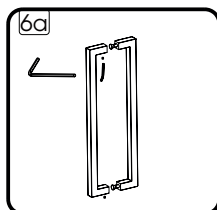

Достоверную информацию уточняйте на [santehnica.ru](http://santehnica.ru).