

C2A / W

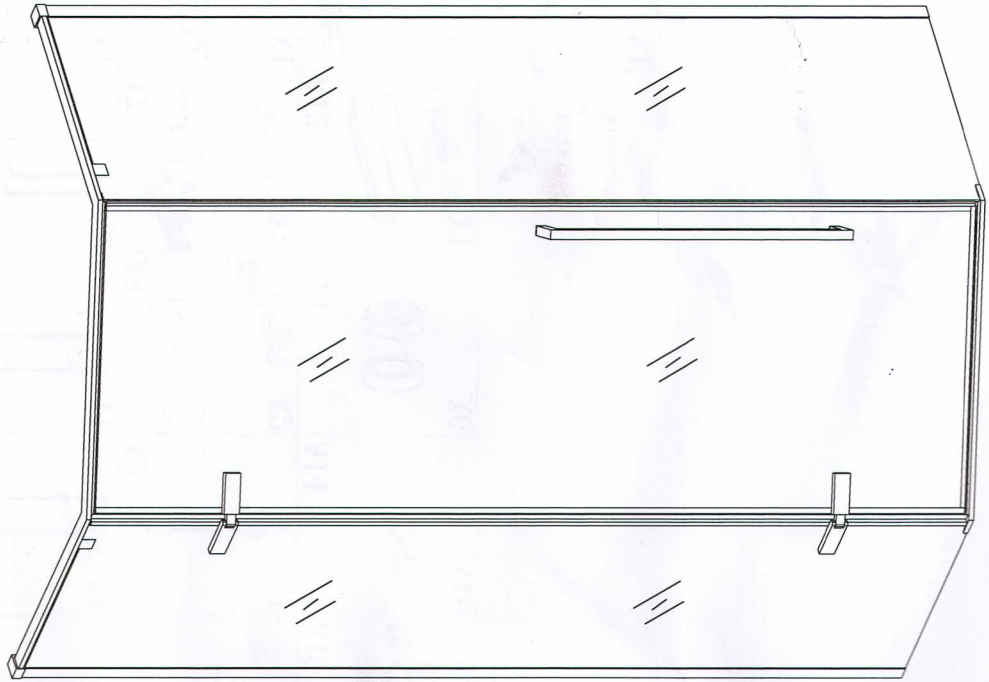

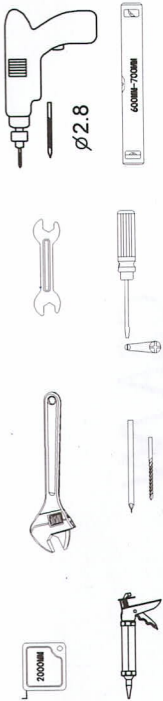

A1	X1	A2	X2	A3	X1	A4	X1	A5	X1
A6	X2	A7	X2	A8	X2	A9	X1	A10	X2
A11	X1	A12	X1	A13	X2	A14	X1	A15	X1
A16	X1								

A1: L1=1925mm, L2=1936mm
 A2: L=628mm
 A10: L1=1925mm, L2=1936mm
 A16: $\phi 2.5$
 ST4X12=6
 ST4X30=8

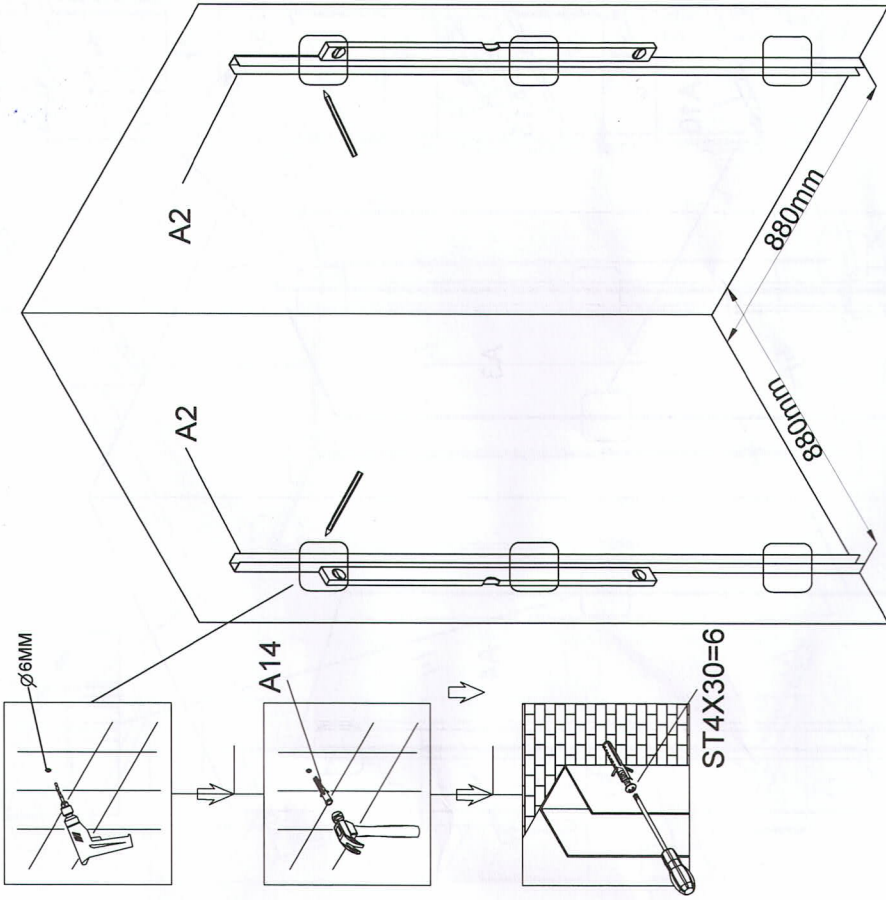

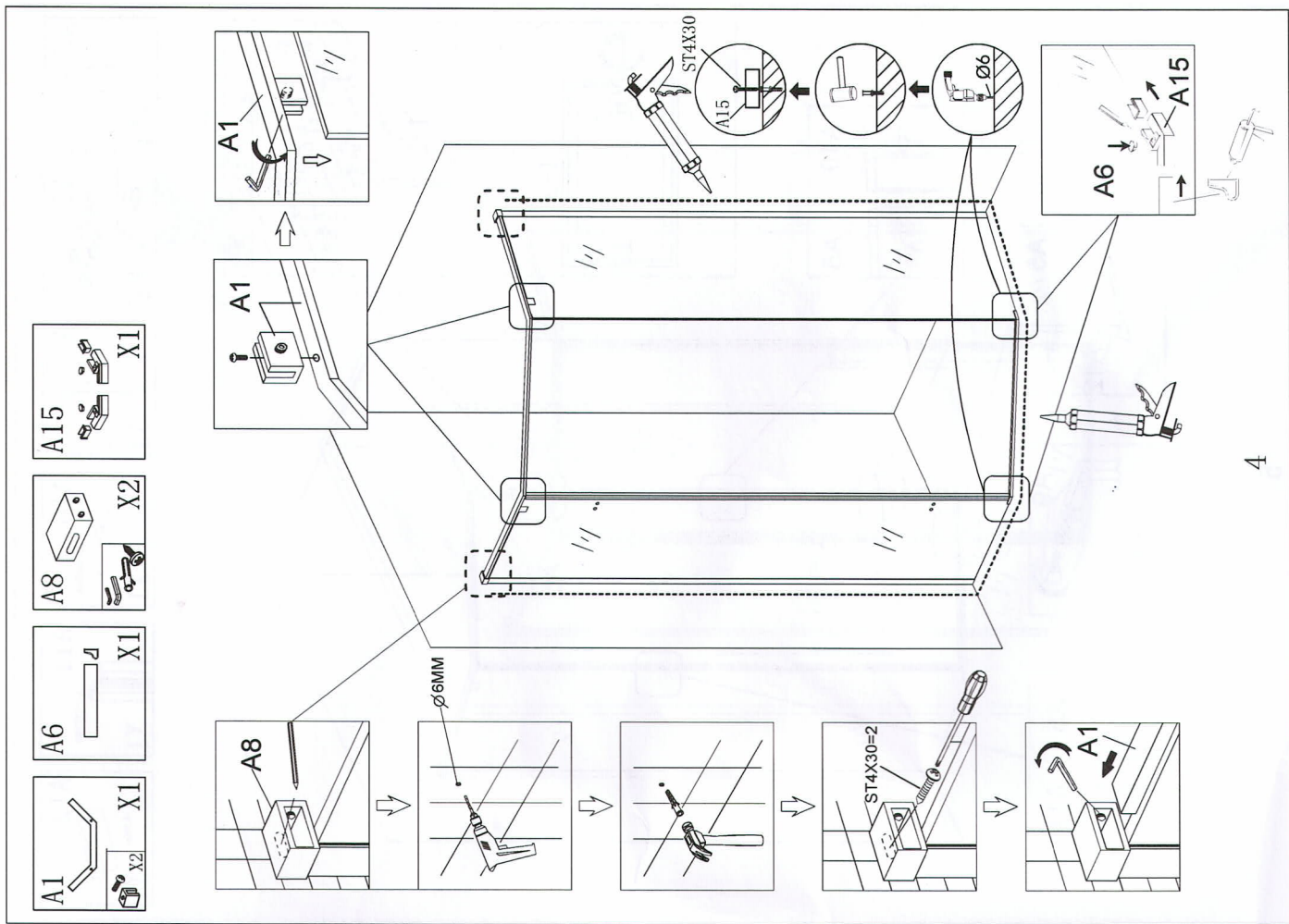
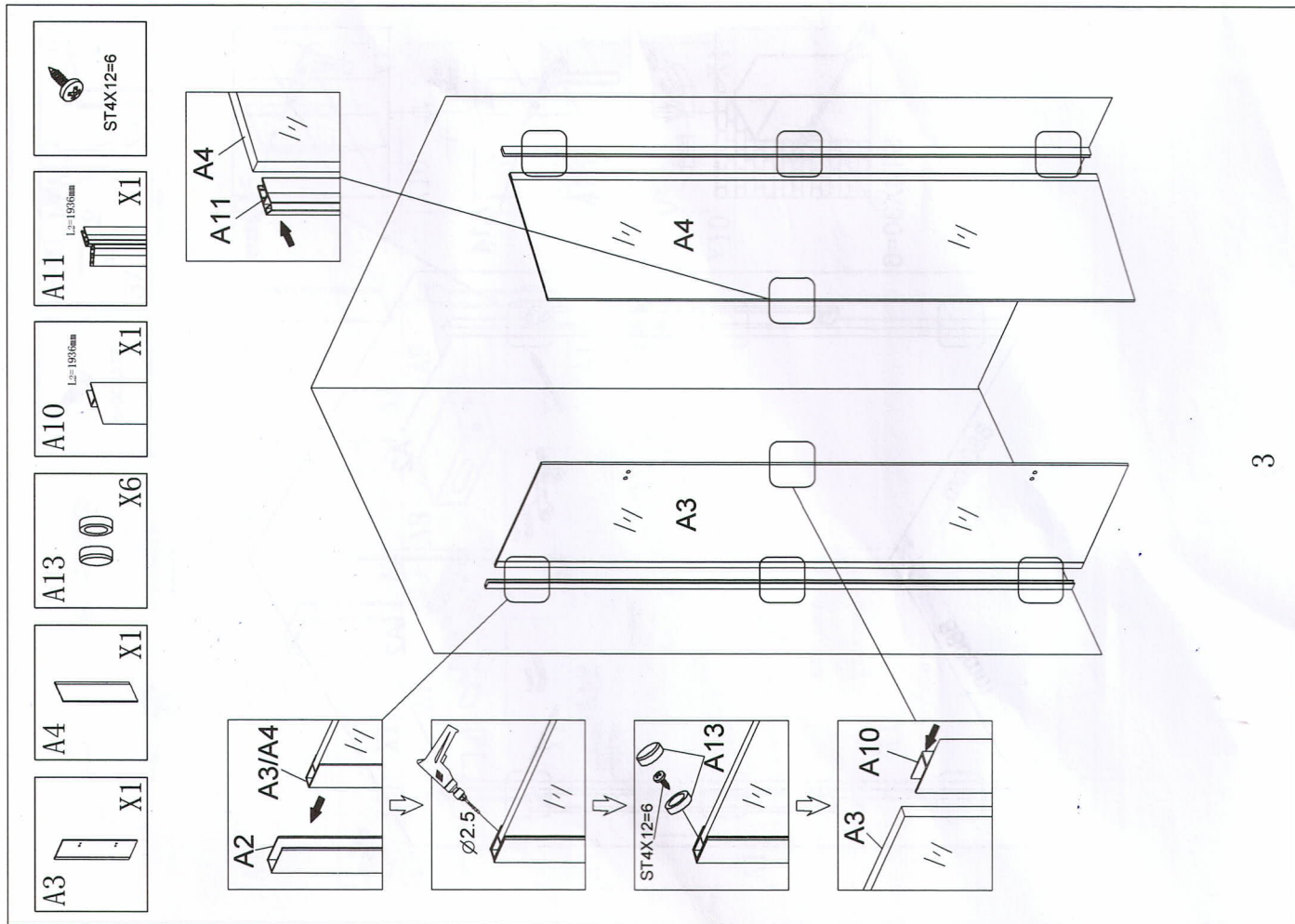

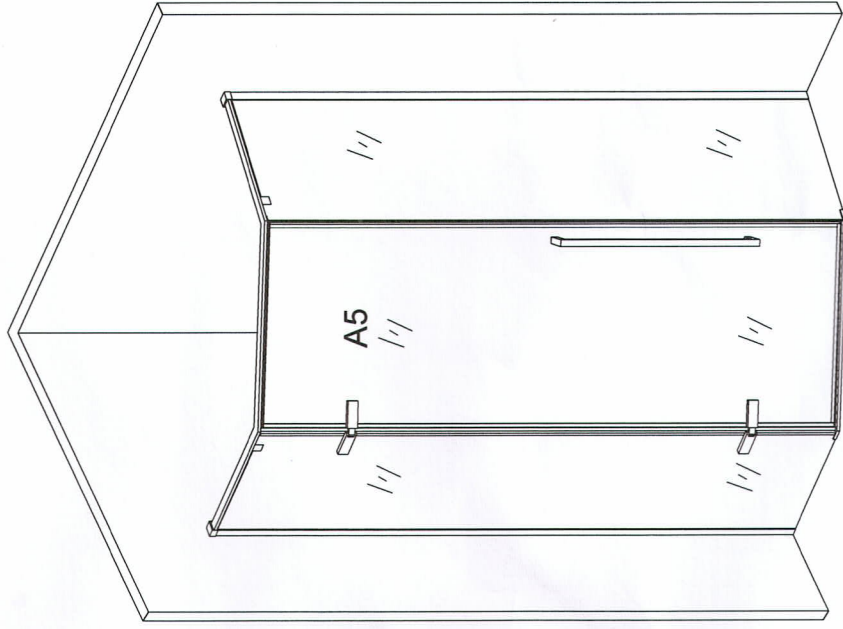
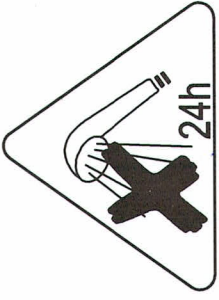

- A5 X1
- A7 X2
- A9 X1
- A10 L1=192.5mm X1
- A11 L1=192.5mm X1
- A12 l=162mm X1

